

OUTLINE DIMENSIONAL DRAWING

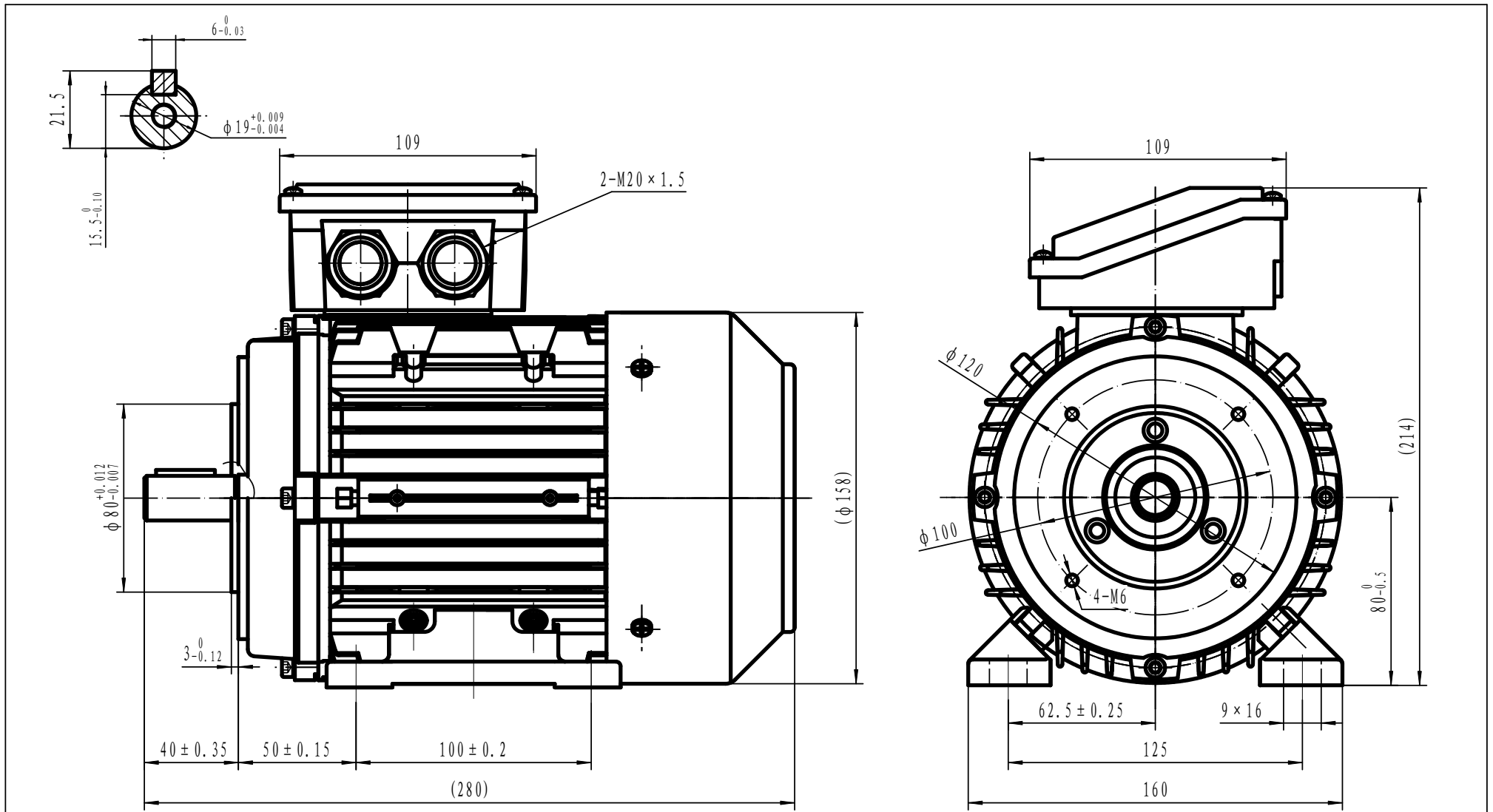

TECHTOP AUSTRALIA PTY LTD	
FRAME	TAI 80A B34
DATE	DRAWING NO.
2011/10/14	1ST083.052.001-020 A